

Technische Dokumentation | Technical documentation



BF 112

Pendeltürbeschläge mit
einstellbarer Nullstellung
Double-action door
fittings with variable zero
positioning



Technische Daten

- Pendeltürbeschläge (nach innen/außen öffnend)
- Türbeschläge mit Federmechanismus
- mehrfach und stufenlos einstellbare Nullstellung
- selbstschließend ab 20° (innen/außen)
- Wandbefestigung mit Langlöchern
- nicht sichtbare Verschraubungen
- nicht sichtbare Kappenbefestigung
- Tragfähigkeit (2 Bänder): 45 kg
- max. Türbreite: 1.000 mm (H: 2.000 mm, 8 mm Glas)
- optimiert zum Einbau ohne Dichtung
- einfache Dichtungsbearbeitung (nur Längenschnitt)
- Türgriff in passendem Design
- Glasstärke: 8 mm
- Grundmaterial: Messing

Standardoberflächen

- glanzverchromt (501)
- ähnlich Niro matt (507)
- velour verchromt (513)
- RAL Sonderfarbe (399)

Sonderoberflächen

- Messing poliert ohne PVD (503)
- Smoke Chrom (505)
- Kupfer unpoliert, ohne PVD (506)
- Sondergalvanik (599)

Technical data

- double-action door (inward/outward opening)
- door fittings with spring mechanism
- adaptable and infinitely variable zero positioning
- self-closing from 20° (inward/outward)
- wall fixing with elongated holes
- non-visible fixing
- invisible cap mount
- load capacity (2 hinges): 45 kg
- max. door width: 1.000 mm (h: 2.000 mm, 8 mm glass)
- optimized for the use without seals
- simplified gasket work (simply cut to length)
- door handle in consistent design
- glass thickness: 8 mm
- basic material: brass

Standard surfaces

- polished chromed (501)
- similar satin stainless steel (507)
- velour chromed (513)
- RAL special coated colour (399)

Special surfaces

- brass polished, without PVD (503)
- smoke chromed (505)
- copper unpolished, without PVD (506)
- special surface (599)

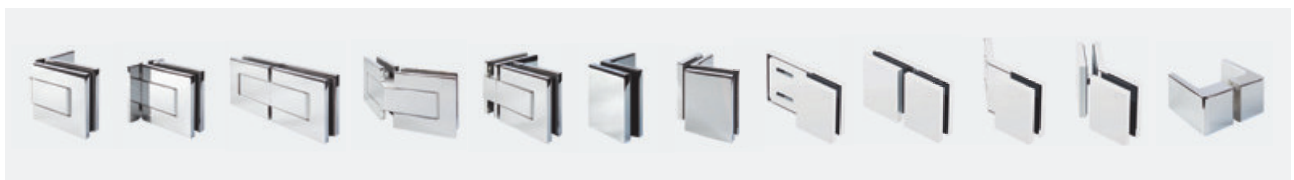

Art.-Nr. 70.184 Art. No. 70.184	Bezeichnung Description	Glasstärke Glass Thickness	Gewicht Weight	Sonderoberfl. Special surfaces	Hinweis Note
	Band Glas/Glas 90° Hinge glass/glass 90°	8 mm	1,50 kg	(599)	Maße/Dichtprofile gelten für 8 mm Glas Measurements/seals valid for 8 mm glass

mit Dichtung | with seals

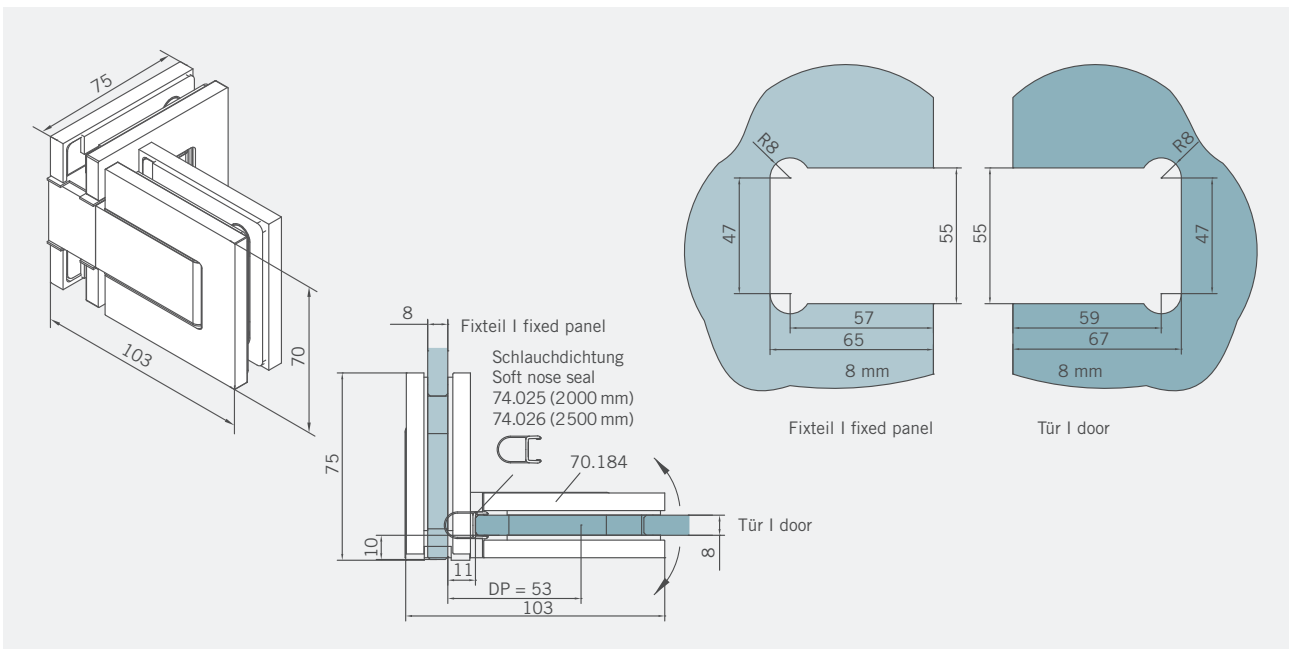

ohne Dichtung | without seals

